

Name: _____

Datum: _____

Add u Subtr mÜdO
im ZR 10000

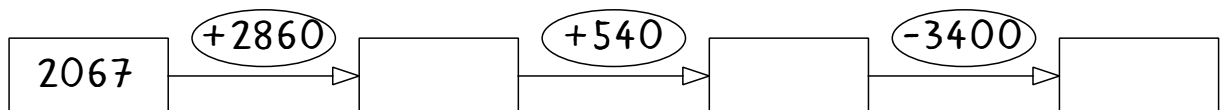
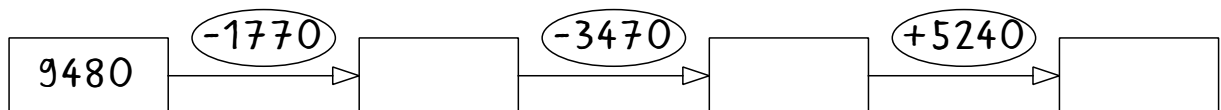
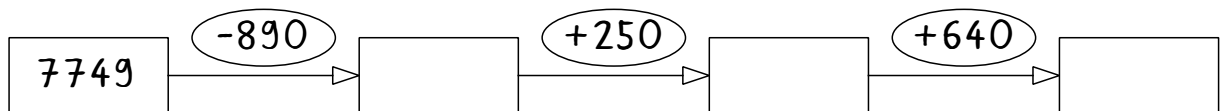
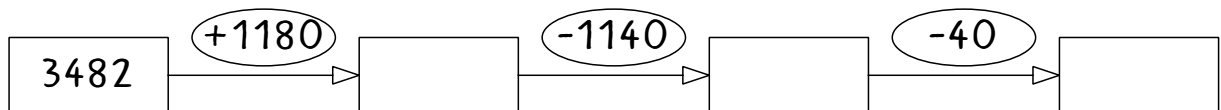
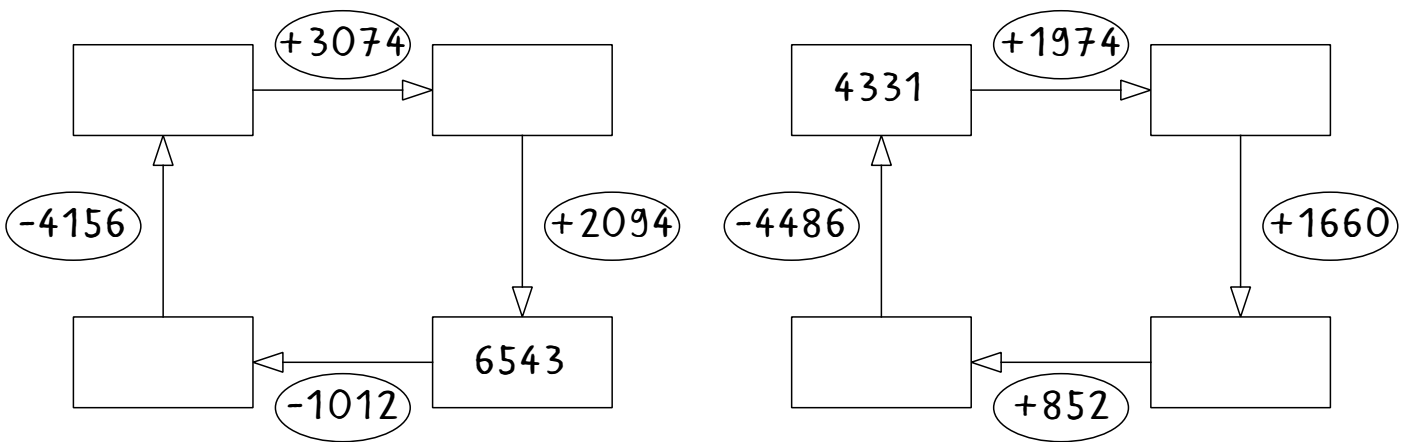
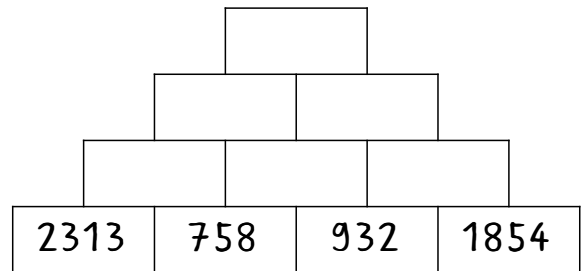
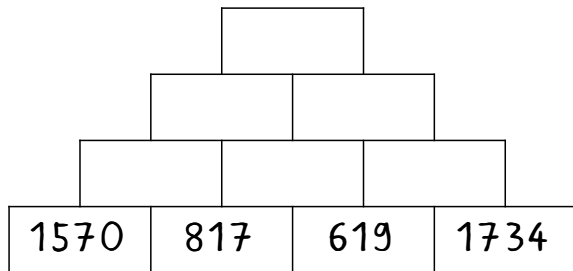

Name: _____

Datum: _____

Add u Subtr mÜdO
im ZR 10000

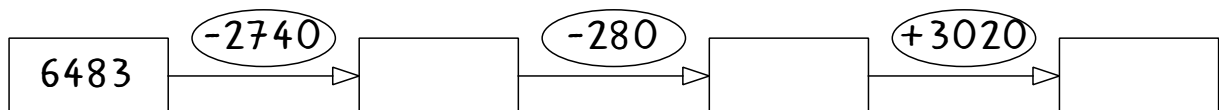
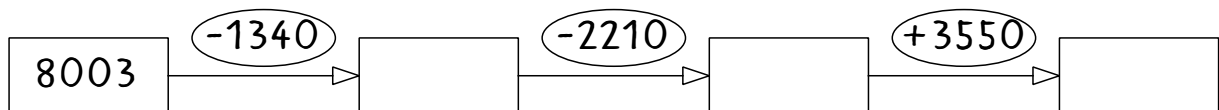
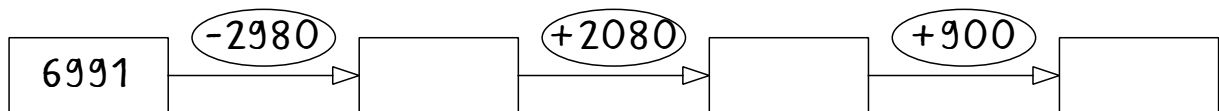
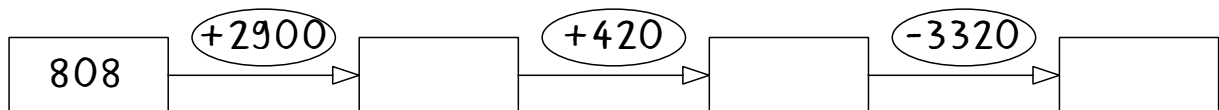
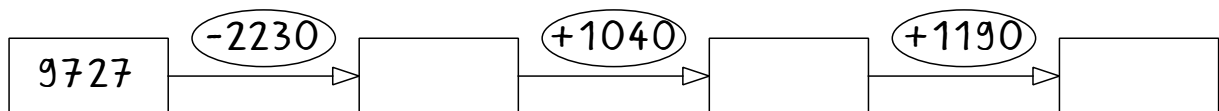
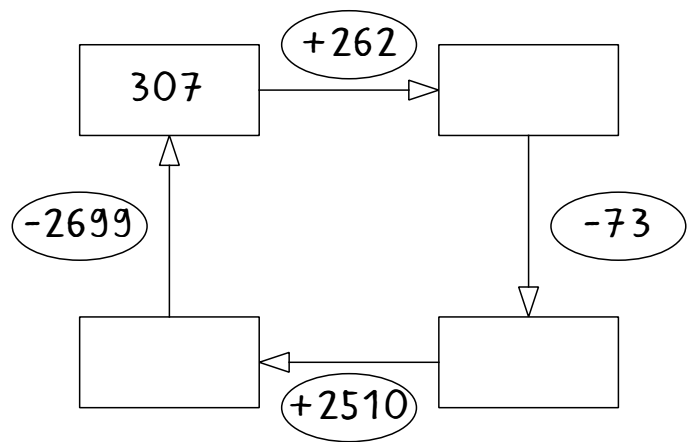
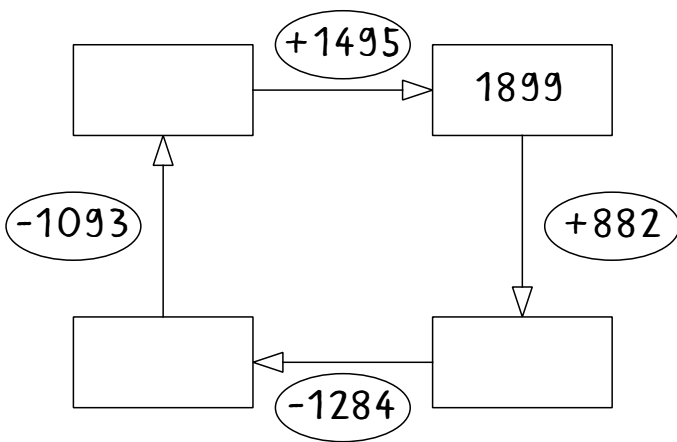
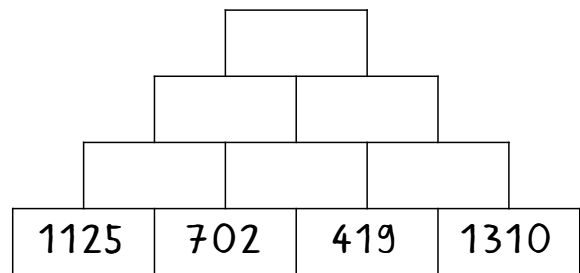
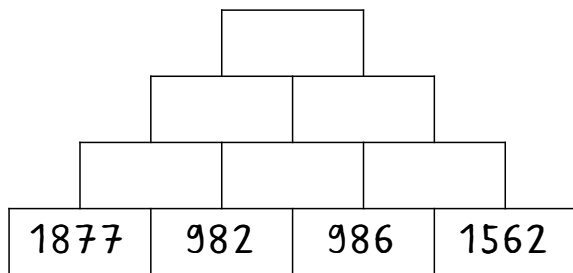

Name: _____

Datum: _____

Add u Subtr mÜdO
im ZR 10000

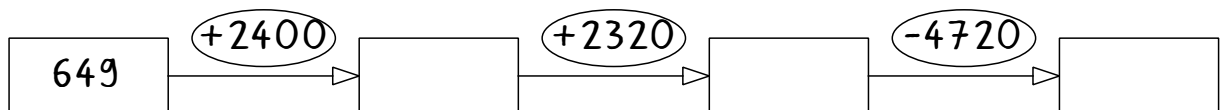
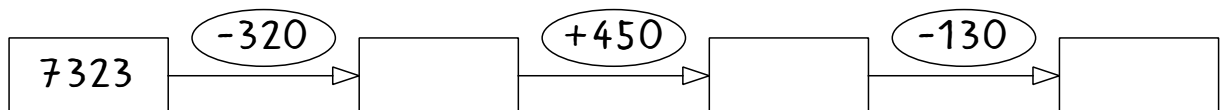
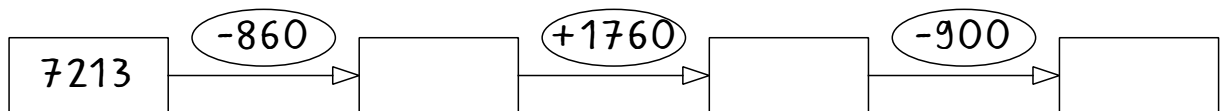
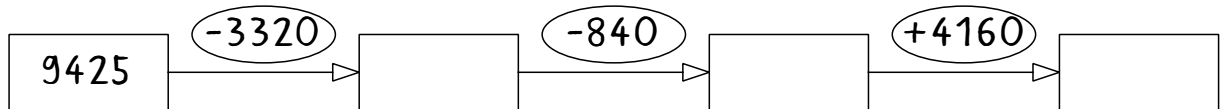
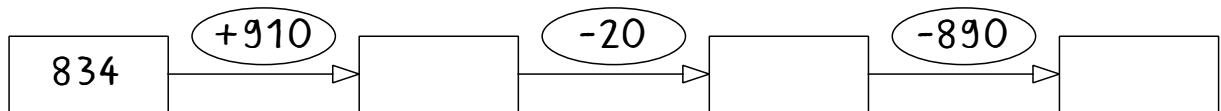
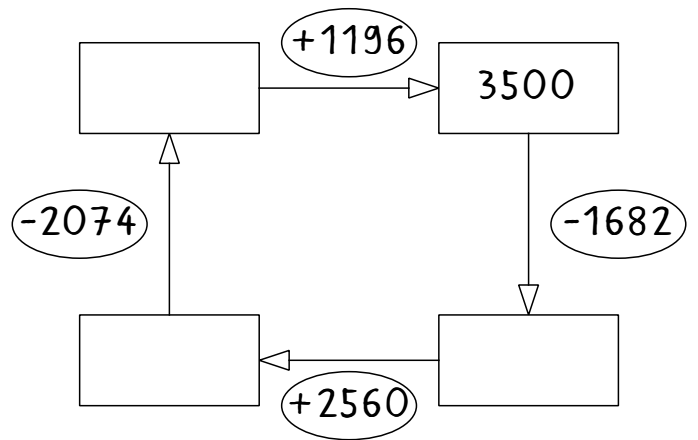
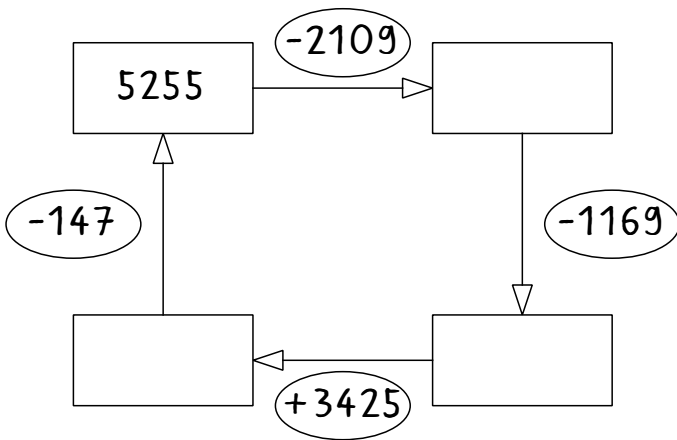
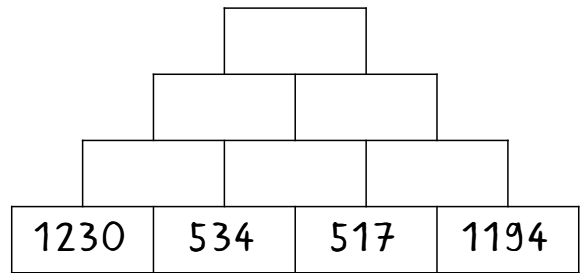
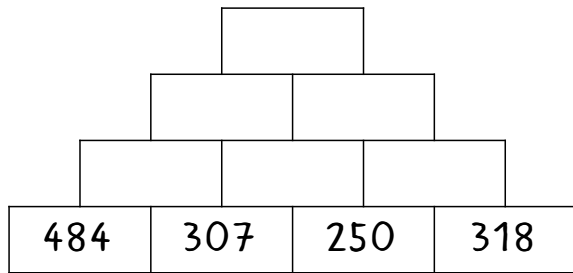

Name: _____

Datum: _____

Add u Subtr mÜdO
im ZR 10000

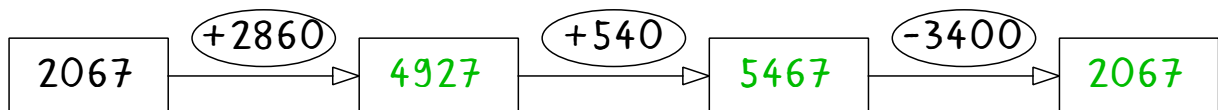
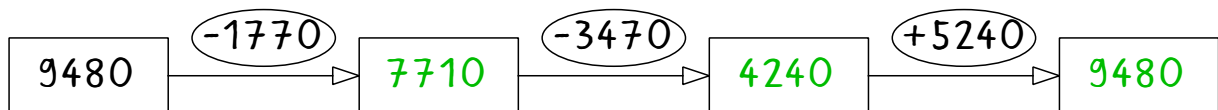
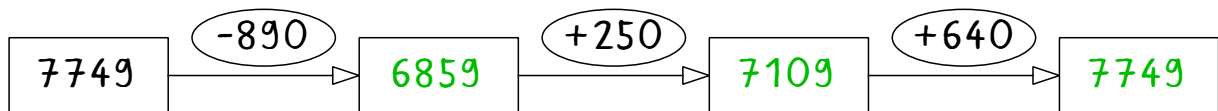
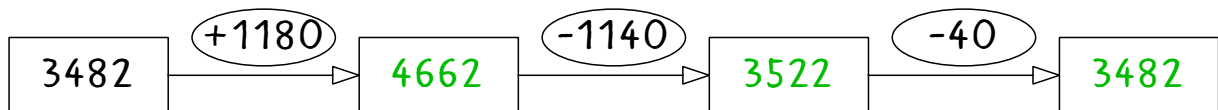
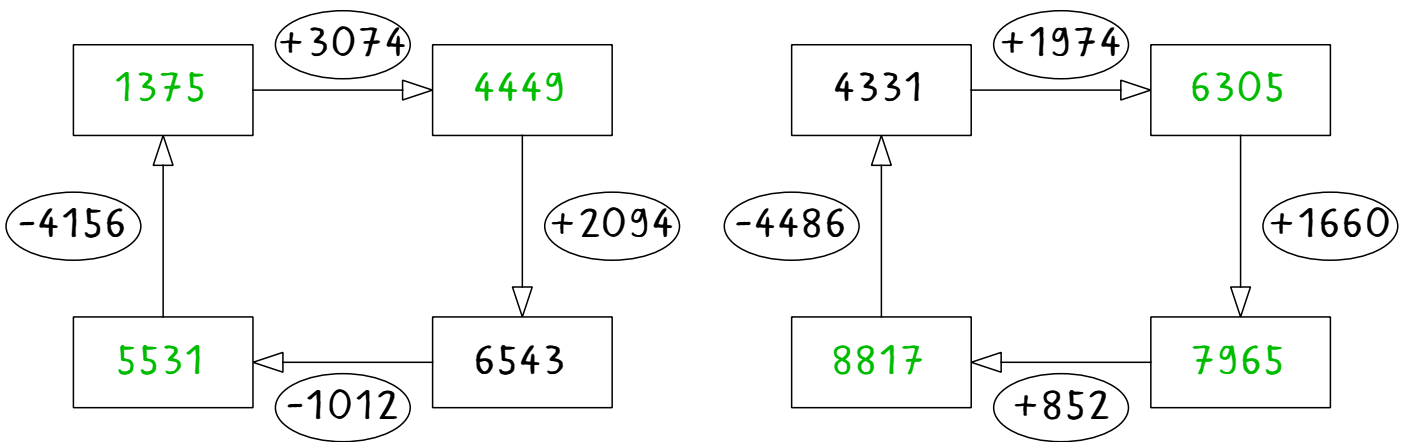
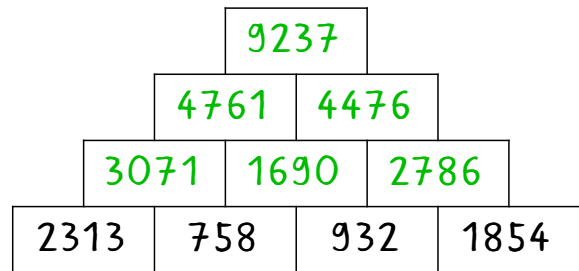
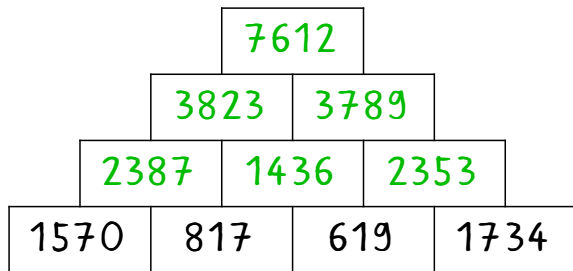

Name: _____

Datum: _____

Add u Subtr mÜdO
im ZR 10000

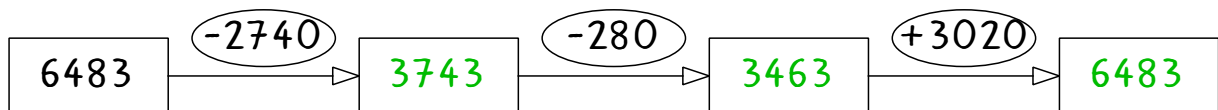
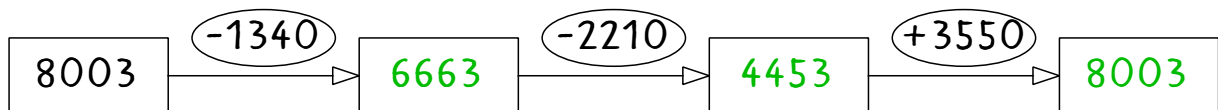
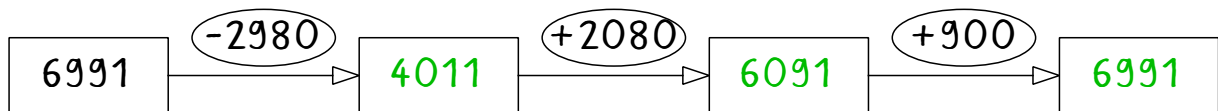
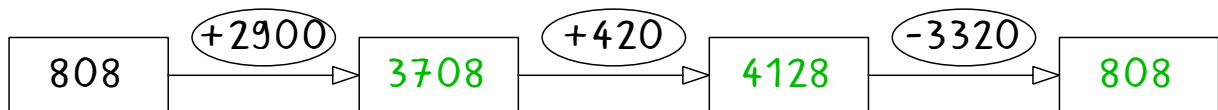
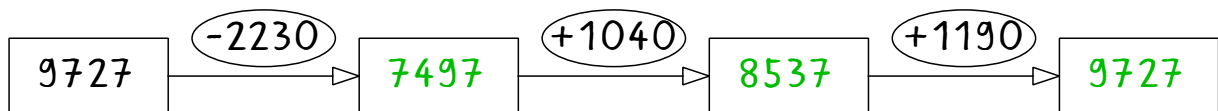
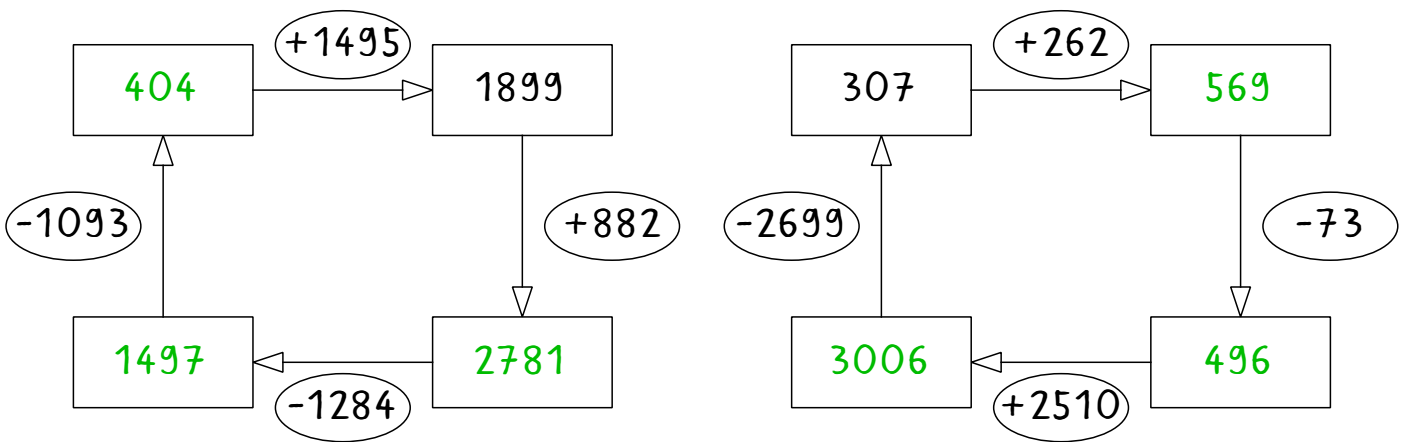
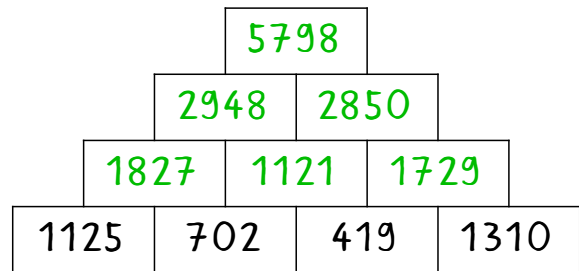
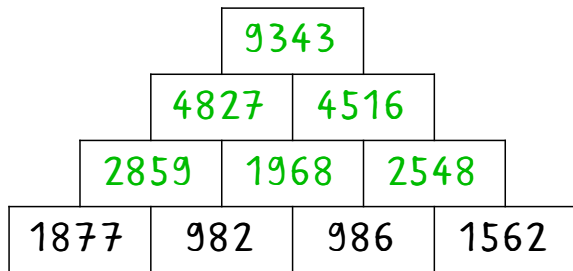

Name: _____

Datum: _____

Add u Subtr mÜdO
im ZR 10000

